

Stand alone unit shown.



Project _____

Type _____

Notes _____

- Ultrathin 3/8" profile in 6 lengths: 10", 16", 23", 30", 36", and 42"
- Switch adjustable CCT : 2700K, 3000K, 3500K, 4000K
- Touchless ON/OFF rocker switch and dimming for runs
- ON/OFF rocker switch on each individual unit
- Linking connectors in 6", 12", and 24" lengths
- Damp location rated
- Wireless remote control option with PIR vacancy sensor

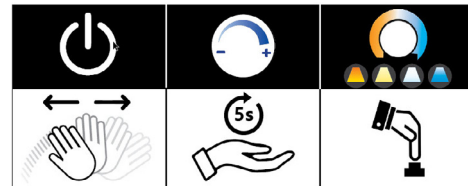

For touch-free On-Off and Dimming:

- Wave hand under sensor to turn the luminaire On-Off
- Hold hand steady under sensor (within 3" from sensor) to dim. Dim cycle is 15 seconds. When desired level of brightness is reached, move hand away from sensor

Please note that dimming is not available with wireless control.

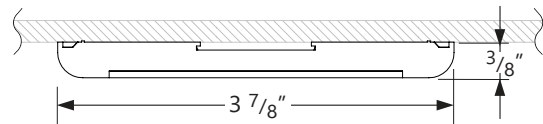

*See ordering code example on page 2



Ordering Guide

BCUC		CONFIGURATION		LENGTH *		CRI	FINISH		MOUNTING	
BCUC	Undercabinet	STA	stand alone	10(#)	10" (QTY)	80	W	SS	Surface Mount	
		RUN	system run	16(#)	16" (QTY)	90	BLK	SM	Surface Magnet Mount	
				23(#)	23" (QTY)					
				30(#)	30" (QTY)					
				36(#)	36" (QTY)					
				42(#)	42" (QTY)					
* Multiple choice lengths option available with Run mounting category. Nominal dimension. Allow space for touchless control unit per individual unit or at end of run (see p.2 configurations).						* Default CRI 80. Consult Factory for 90 CRI				

VOLTAGE		DRIVER		CONTROLS		ACCESSORIES (OPT.)					
120	120 V	24W	24 W wall plug*	TCU	touch control	CDP(L)	cord & plug* (!)				
277	277 V	RDE10(L)	remote driver enclosure 10" (!)	WCU	wireless control	+LNK6(#)	joinder linking connector*				
UNV	universal	RDE14(L)	remote driver enclosure 14" with hospital grade single (non-GFI) convenience outlet** (!)		wall switch*	+LNK12(#)	linking connector, 6" *				
						+LNK24(#)	linking connector 12" *				
						+USB	USB charging port (5V, 1A max)				
Consult factory for other voltage.		* Max 42" total run length. Available with 120V only. ** Available only for 14" remote driver enclosure (RDE14(L)), see details on page 3. (!) Specify power cord length; standard lengths 20", 39", 59", 119" (consult factory for other lengths and lead time). Max 126" total run length per RDE (100W driver). e.g., (3) 42" units		* With either touch control for CCT and intensity, or PIR vacancy sensor option.		(!) Available cord lengths are 2ft, 4ft, 8ft and 15ft, please specify (Ex.: CDP(8)). Only available with RDE10, RDE14. 10' power cord supplied if CDP not selected. * Connectors for system run mounting category. See page 2 for configuration examples.					

● SINGLE LUMINAIRE CONFIGURATION

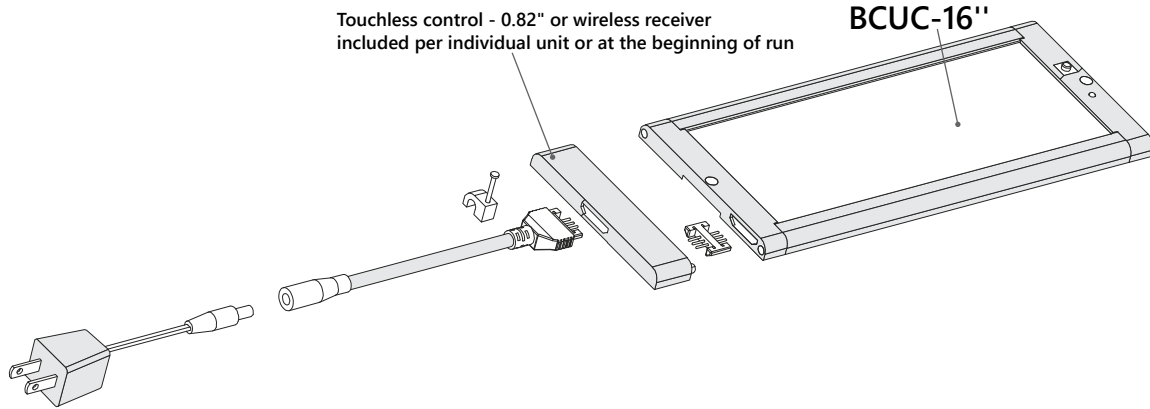

Ordering example: BCUC-STA-16(1)-80-W-SS-120-24W

● SYSTEM RUN CONFIGURATION

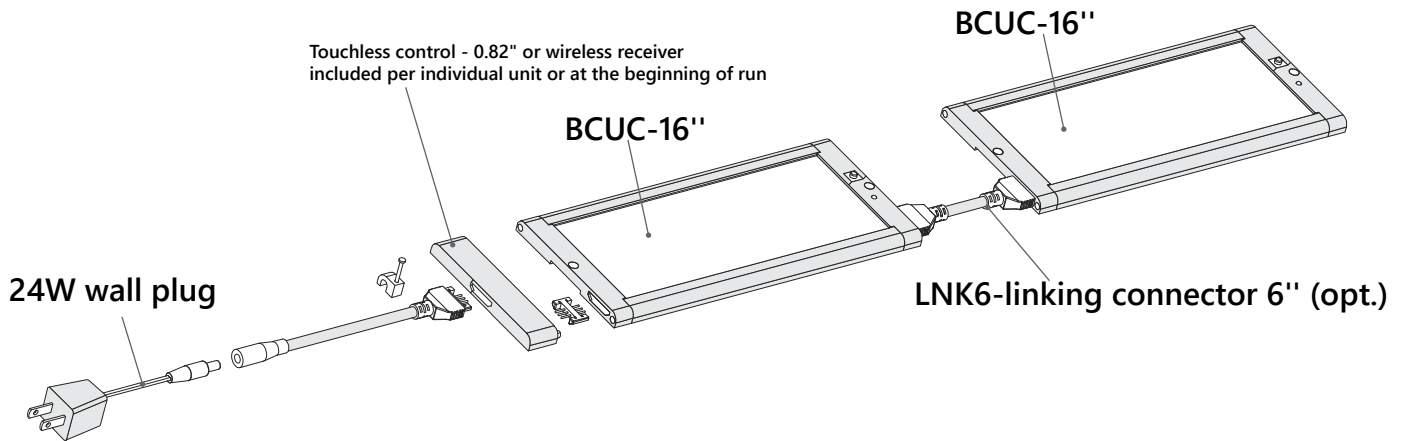

Ordering example: BCUC-RUN-16(2)-80-W-SS-120-24W-TCU-LNK6(1) for system run shown with one 6" linking connector.

● SYSTEM RUN CONFIGURATION

RDE14 - remote enclosure with convenience outlet

24W wall plug available (optional)

(20) - 20" power cord length (L)

USB port

Touchless control - 0.82" or wireless receiver included per individual unit or at the beginning of run

BCUC-16''

BCUC-16''

BCUC-30''

LNK - Joiner linking connector (opt)

LNK6-linking connector 6" (opt.)

loose wire connecting directly to j-box

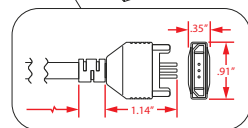

Ordering example: BCUC-RUN-16(2)+30(1)-80-W-120-RDE14(20)-TCU+LNK(1)+LNK6(2)+USB for system run shown with USB option, two 6" linking connectors and one joiner connector.

● CONSTRUCTION

Housing	Extruded aluminum
End Cap	ABS
Light Guide	PMMA
Lens	Diffused acrylic

● ELECTRICAL

Power supply	24V low voltage safe for all under cabinet units; 24W remote wall plug supporting maximum of 42" total system run length.
Adjustability	Master control for switch selectable CCT and brightness for entire system run
Touchless dimming	Position hand beneath the ON/OFF touchless sensor, without moving, until dimming is activated and desired light level has been achieved. Adjustment from lowest brightness to highest brightness – and reverse – occurs over 5.5 seconds. At each end of the brightness range, the adjustment pauses 2 seconds.
Remote enclosure	100W supports maximum of 126" total system run length.
Input Voltage	120V, 277V, UNV.

i Incorporating these components may have limitations or affect the length of the luminaire. Please contact factory for more details.

● LED SYSTEM

CRI	Minimum 80 color rendering index
CCT	Choice of 2700K, 3000K, 3500K and 4000K
LED life	Minimum 50,000h with 70% of lumen maintenance in 25°C ambient temperature, in compliance with IES LM-70 testing measurements.
Thermal management	Aluminium housing acting as the heat sink to maximize life.

● LIGHT GUIDE

Precision light guide made of PMMA material allows distribution of controlled light. In plane mixing maximizes uniformity. White light emitting area is uniform and diffuse.

● WEIGHT

Undercabinet 10"	0.48 lbs / 0.22 kg
Undercabinet 16"	0.78 lbs / 0.35 kg
Undercabinet 23"	1.13 lbs / 0.51 kg
Undercabinet 30"	1.49 lbs / 0.68 kg
Undercabinet 36"	1.80 lbs / 0.82 kg
Undercabinet 42"	2.10 lbs / 0.95 kg

● APPROVALS

Certified to UL and cUL standards .
Suitable for damp locations.

● WARRANTY

BalancedCare™ by Axis Lighting will warrant defective LEDs, boards, and drivers for 5 years from date of purchase. Warranty is valid if luminaire is installed and used according to specifications. If defective, BalancedCare™ will send replacement boards or drivers at no cost along with detailed replacement instructions and instructions on how to return defective components to BalancedCare™.

● FIXTURE AND ACCESSORIES

Fixture

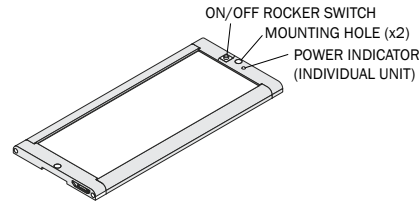

Touchless control

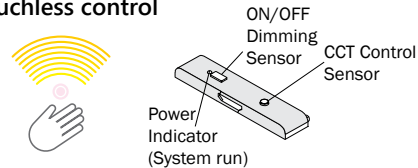

Wall Switch (WCU)

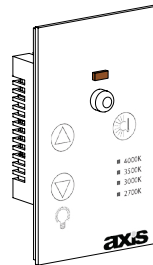

Wireless receiver

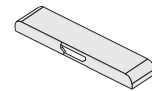

USB port (USB)

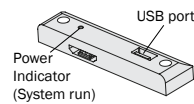

120 V Adapter



Standard Remote driver enclosure (RDE10(L)).

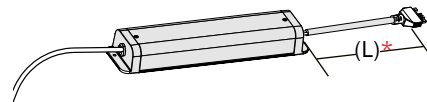

Remote driver enclosure (RDE14(L)), comes with optional hospital grade single (non-GFI) convenience outlet.

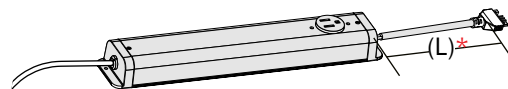

* When ordering please specify power cord length. Standard lengths are 20", 39" and 59", other lengths available, please consult factory. (Ex.: RDE10(20), RDE14(59), etc.)

Interconnect cordset



● PHOTOMETRIC DATA

UNDERCABINET 4000K

BCUC-STA-16-80-W-120-24

PHOTOMETRIC CURVE

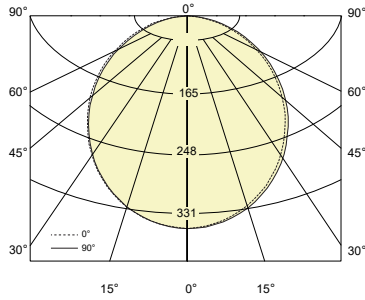

Luminaire Lumens: 942 lm

Input Watts: 10.42 W

Efficacy: 90 lm/W

IES FILE: BCUC-STA-16-80-W-120-24.ies

TESTED ACCORDING TO IES LM-79-2008

CANDELA DISTRIBUTION

Vertical Angle	Horizontal Angles				
	0	22.5	45	67.5	90
0	329	329	329	329	329
5	326	326	326	327	328
15	313	313	314	315	316
25	289	290	291	292	294
35	255	256	258	259	262
45	214	215	217	219	221
55	167	168	170	172	174
65	115	116	118	120	122
75	62	63	65	67	69
85	16	16	18	19	21
90	0	0	0	1	1

ZONAL LUMENS

Zone	Lumens
0	
0-10	31
10-20	89
20-30	135
30-40	162
40-50	168
50-60	152
60-70	117
70-80	69
80-90	20
90	0

LUMINANCE DATA (cd/m²)

Vertical Angle	Horizontal Angles		
	0	45	90
45	11163	11312	11517
55	10726	10926	11183
65	10026	10277	10639
75	8885	9255	9792
85	6665	7637	8945